



**CZ - NÁVOD NA MONTÁŽ A ÚDRŽBU**  
**SK - NÁVOD NA MONTÁŽ A ÚDRŽBU**

**Vyvýšený záhon / vyvýšený záhon**

**KARIBU**

**CZ - Před stavbou si přečtěte až do konce tento montážní návod**

**SK - Pred stavbou si prečítajte až do konca tento montážny návod**

# Vyvýšený záhon KARIBU

81215

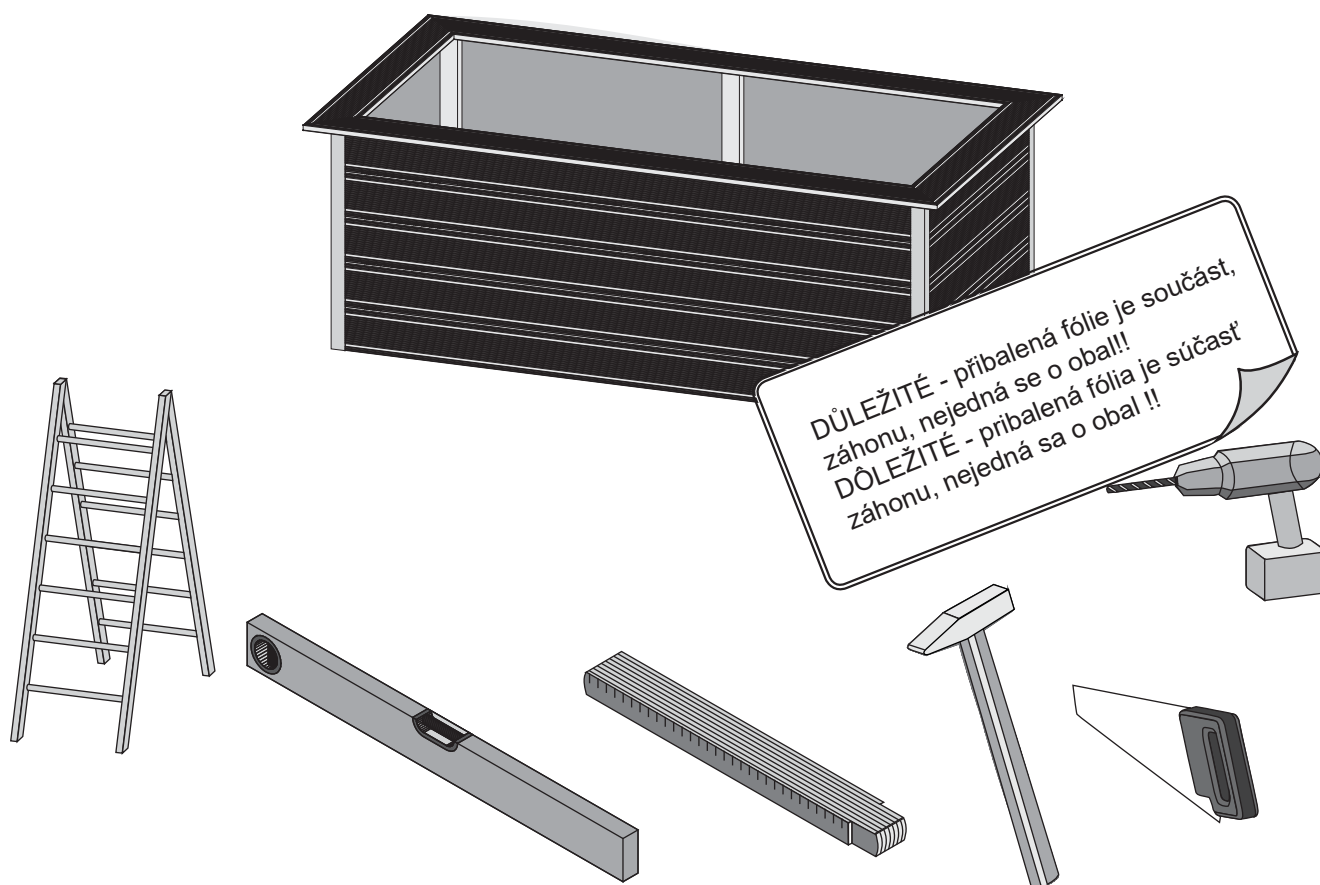

 **Aufbauanleitung**

 **Building Instructions**

 **notice de montage**

 **montagehandleiding**

 **Montagevejledning**

 **Instrucciones de construcción**

 **Istruzioni per il montaggio**

 **Montážní návod**

 **Montážny návod**



+49 421 38693 33



Vergleichen Sie zuerst die Materialliste mit Ihrem Paketinhalt! Bitte haben Sie Verständnis, dass Beanstandungen nur im nicht aufgebauten Zustand bearbeitet werden können!



En primer lugar, compare la lista de material con el contenido del paquete. Rogamos entienda que las reclamaciones sólo pueden ser tramitadas antes de montar el objeto!



Před začátkem montáže zkontrolujte obsah balení! Montážní návod Vám pomůže s identifikací dílů.



Vergelijk eerst de lijst van materialen met de inhoud van uw pakket! Reclamaties kunnen alleen in behandeling worden genomen zolang de onderdelen nog niet zijn gemonteerd!



First compare the list of materials with your package contents! Please understand that complaints can be processed in the non-built status only!



Pred začiatkom montáže skontrolujte obsah balenia! Montážny návod Vám pomôže s identifikáciou dielov.



Commencez par comparer la liste du matériel avec le contenu de votre paquet! Sachez que nous traitons uniquement les réclamations concernant le matériel à l'état non monté!



Confrontate questa distinta materiali prima con il contenuto del pacchetto! Vi preghiamo di comprendere che eventuali reclami possono essere accolti solo prima del montaggio!

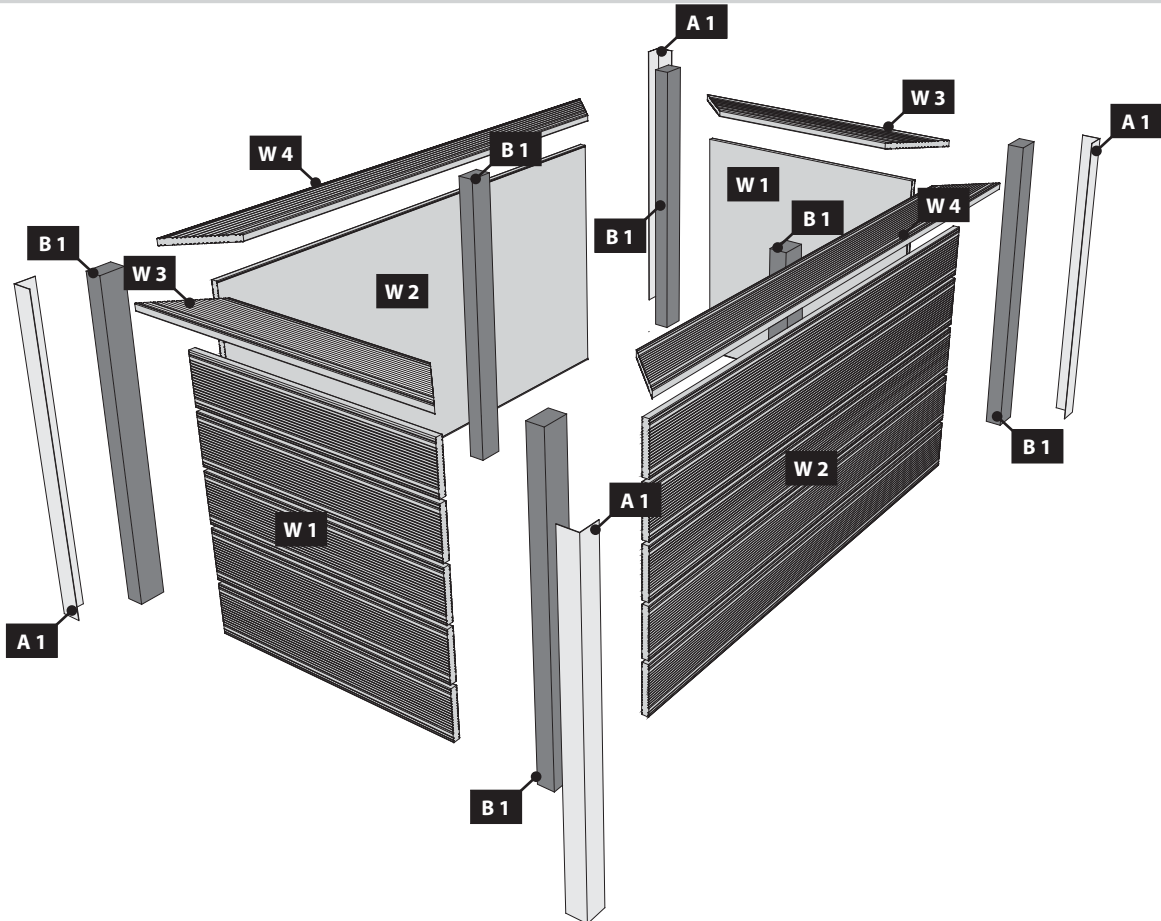
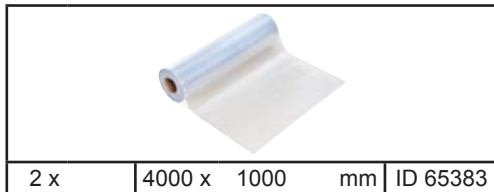
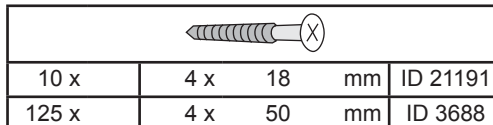
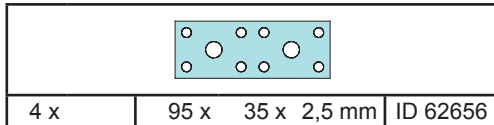
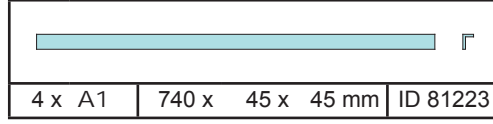
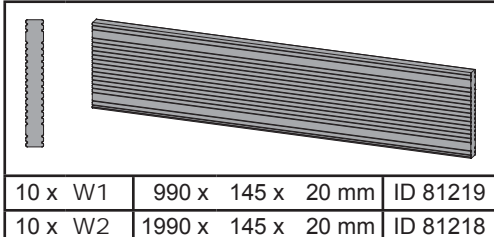
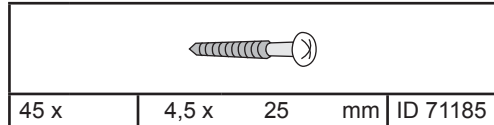
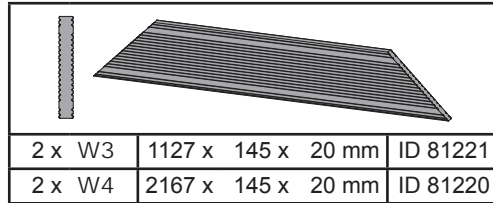
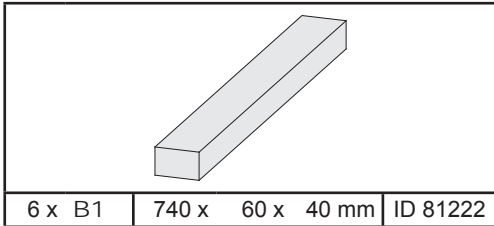
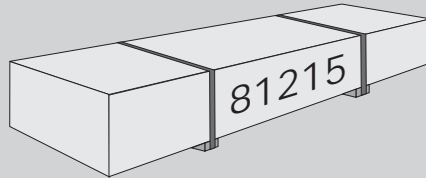

01 2x

-  Bündig!
-  Flush!
-  Affleurement!
-  Gelijk!
-  I flugt!
-  Aras!
-  Zarovnat' !
-  Zarovnat' !

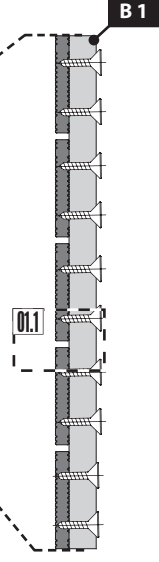

Ø3 mm 4x50  
40x

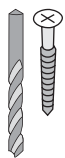
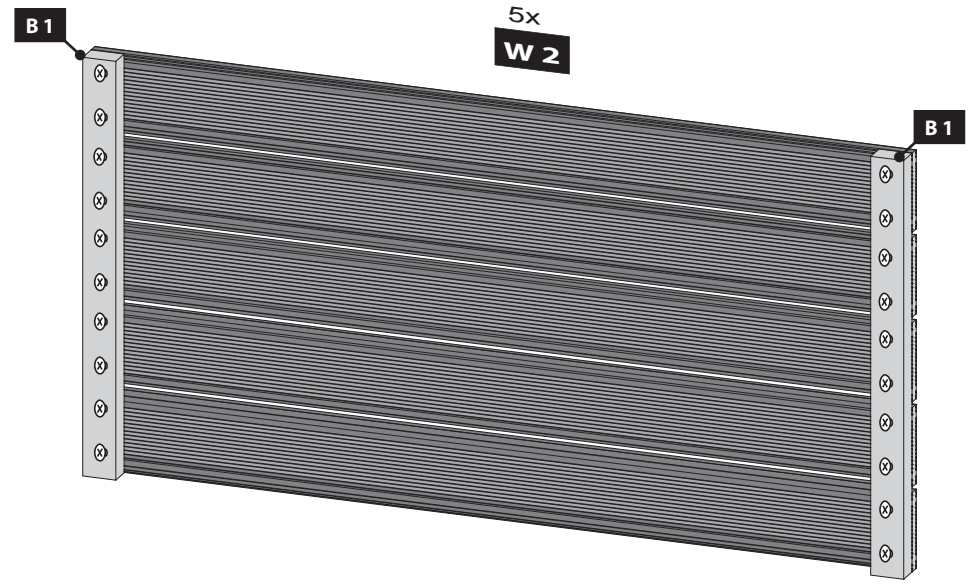
01.1

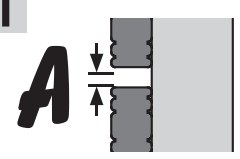

02 2x

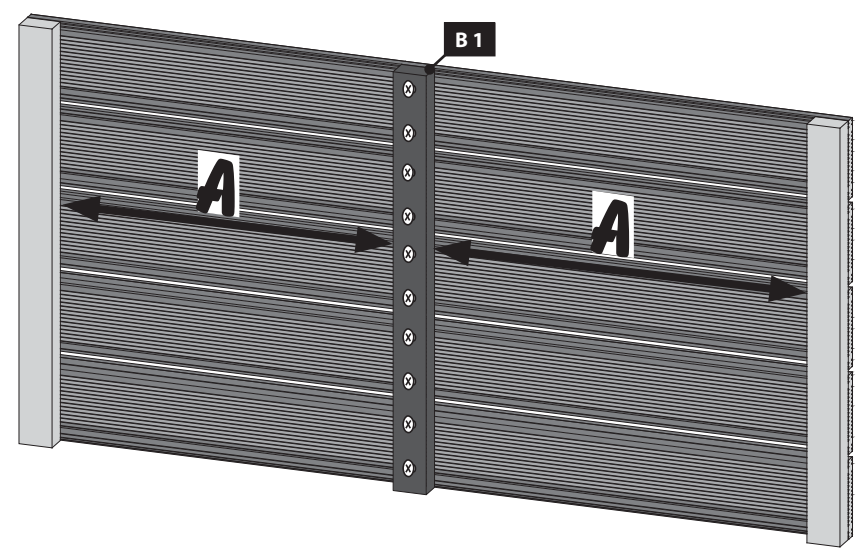

Ø3 mm 4x50  
20x

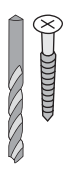
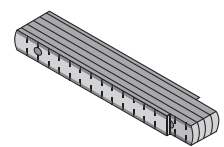
03

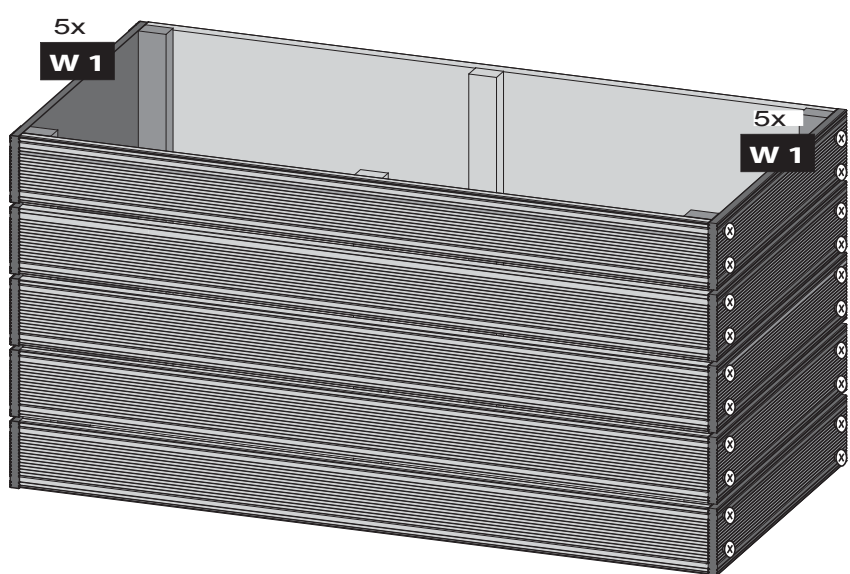

Ø3 mm 4x50  
40x

04

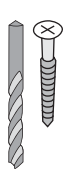
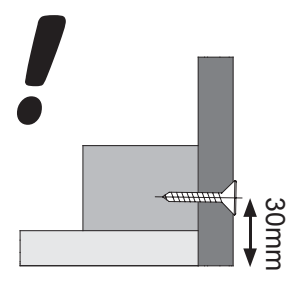

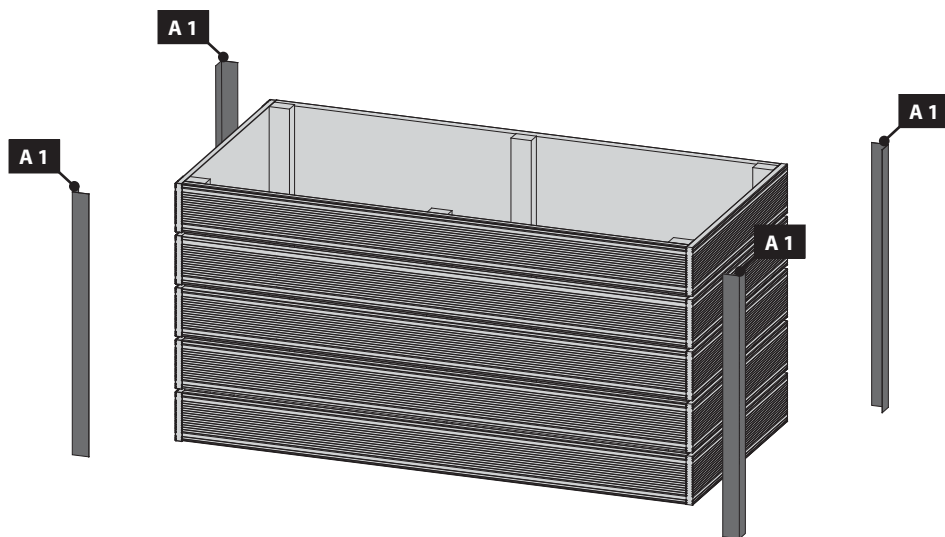
05

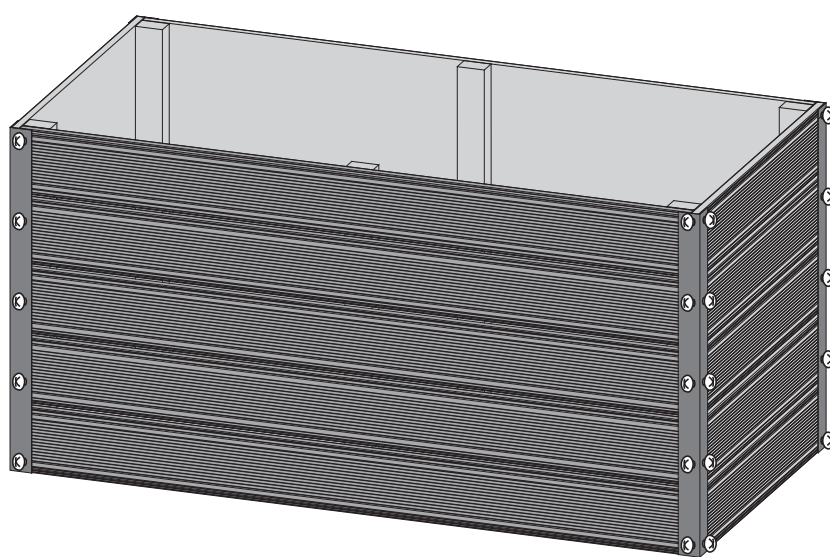

Ø3 mm 4,5×25

06

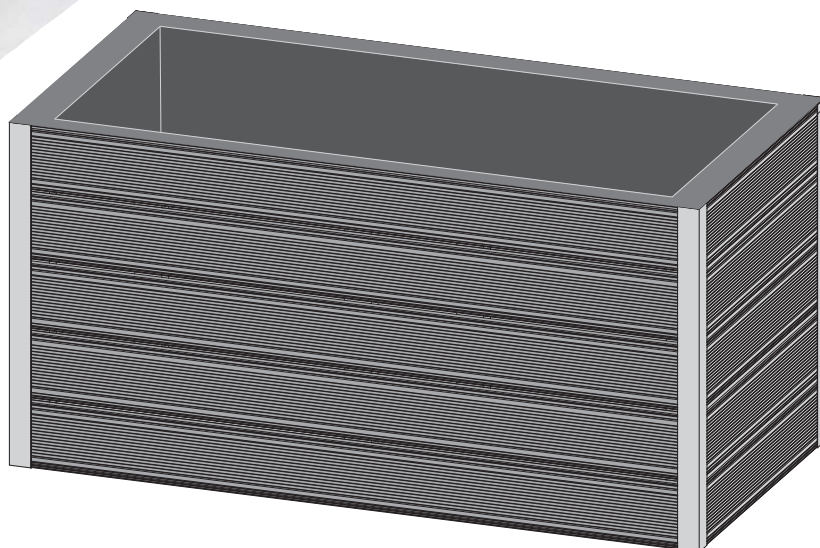

- \*  Nicht im Lieferumfang enthalten  
 \*  Non comprises dans la livraison  
 \*  Not included  
 \*  Niet bijgeleverd  
 \*  No forman parte del suministro  
 \*  Není součástí balení  
 \*  Nie je súčasťou balenia

07

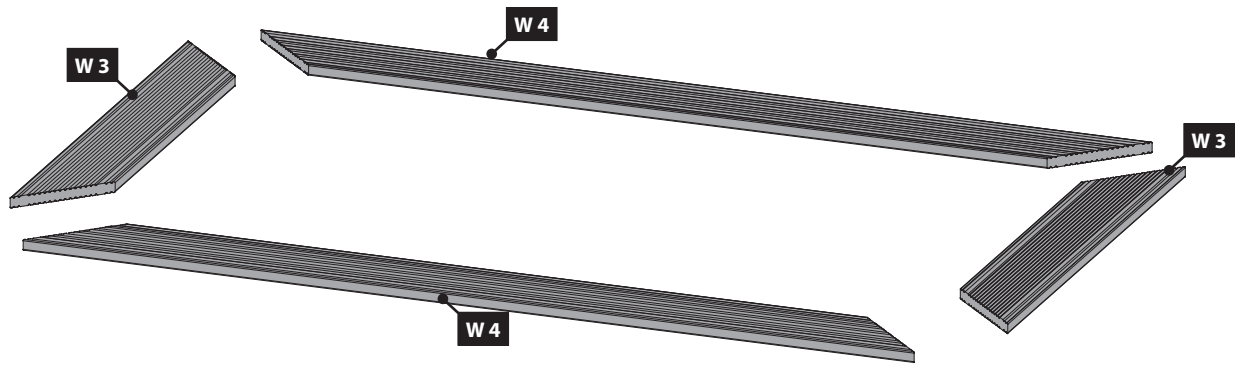

08

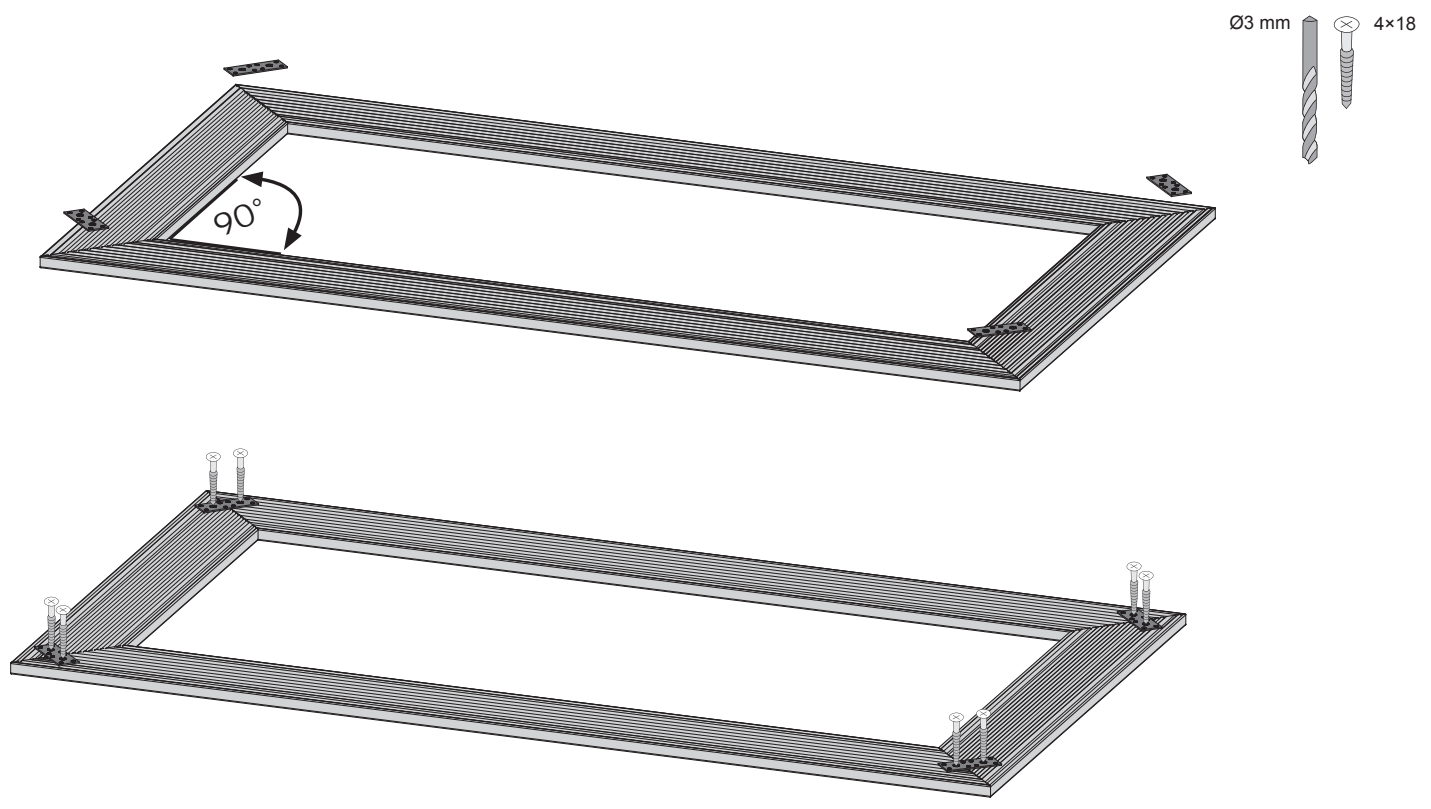

09

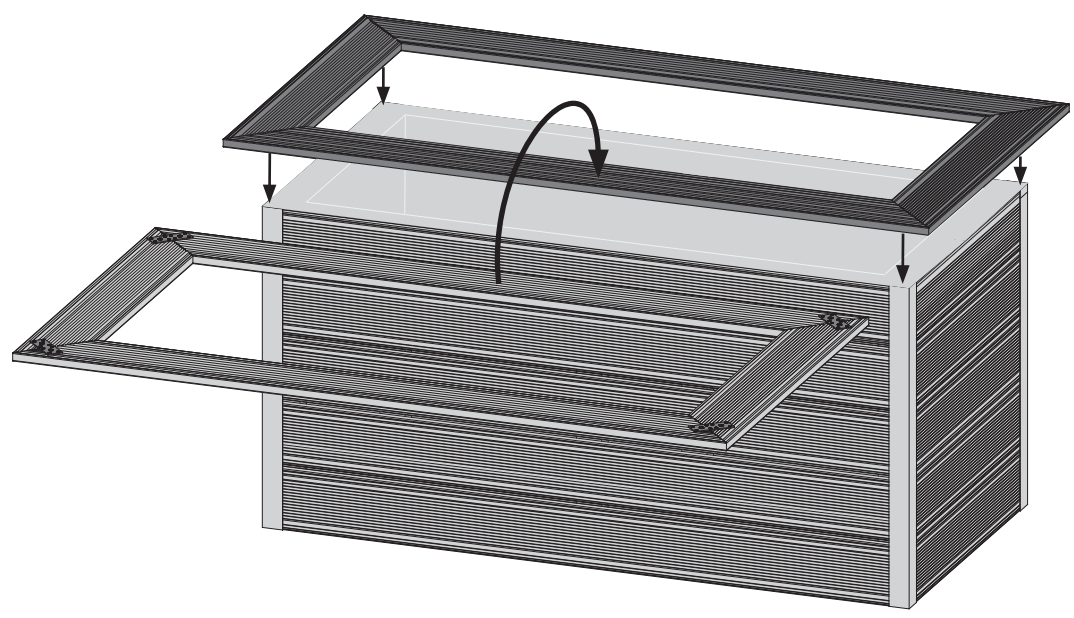

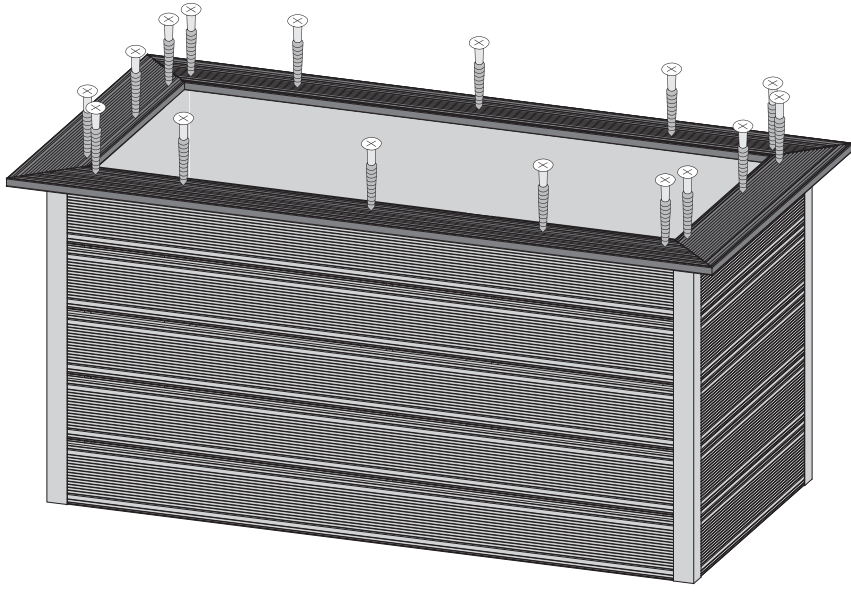
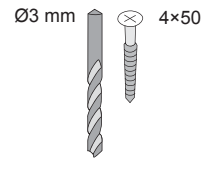



Hochbeet befüllen	goed invullen	riempire correttamente
remplir correctement	llenar correctamente	správně vyplnit
naplnit správně		



  



<b>A</b>	Gartenerde / Kompost
<b>B</b>	Laub / Grünschnitt
<b>C</b>	Gehölzschnitt fein
<b>D</b>	Grobe Äste / Zweige

- Lieber Kunde, achten Sie auf die richtige Befüllung!
- Geachte klant, let op de juiste vulling!
- Dear customer, pay attention to the correct filling!
- Cher client, faites attention au bon remplissage!
- Estimado cliente, presta atención al llenado correcto!
- Caro cliente, prestare attenzione al corretto riempimento!
- Naplňte vhodným obsahem!
- Naplňte vhodným obsahem!

 Hochbeet befüllen  
 remplir correctement  
 fill properly

 goed invullen  
 llenar correctamente

 riempire correttamente  
 Naplňte vhodným obsahem!  
 Naplňte vhodným obsahom!

**A**

Gartenerde / Kompost / Zemina

**B**

Laub / Grünschnitt / Lupení / Lupene

**C**

Gehölzschnitt fein / Ořez / Orez

**D**

Grobe Äste / Zweige / Větve / Vetvy

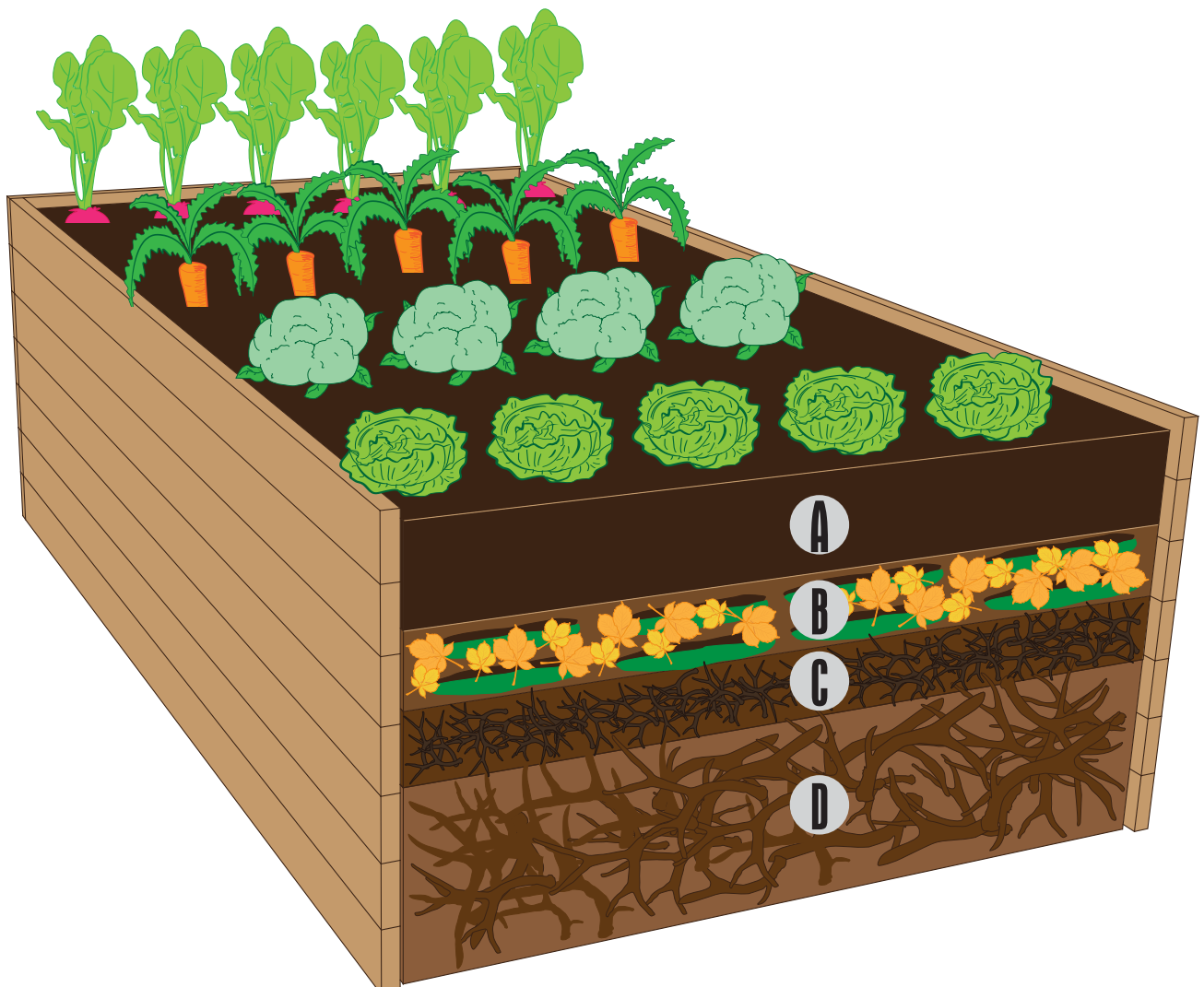



**Váš dodavatel / Váš dodávateľ**



[www.lanitgarden.cz](http://www.lanitgarden.cz)

*V případě naléhavých dotazů se obraťte  
na naši technickou podporu*

*V prípade naliehavých otázok sa obráťte  
na našu technickú podporu*

**[technik@lanitplast.cz](mailto:technik@lanitplast.cz)**